

DPDT SWITCH GaAs MMIC

■GENERAL DESCRIPTION

NJG1528KC1 is a GaAs high power DPDT switch MMIC for antenna switch of tri- and dual-mode cellular phone application such as CDMA, AMPS and PCS.

This switch features low loss, high isolation at high power.

The ultra small & ultra thin FLP10 package is applied.

■PACKAGE OUTLINE

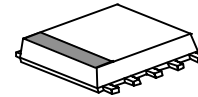

NJG1528KC1

■FEATURES

- Low voltage operation 2.5V min.
- Pin at 0.2dB compression point 36dBm typ. @f=1.9GHz, $V_{CTL}=2.8V$
- Low insertion loss 0.60dB typ. @f=0.9GHz, $P_{IN}=31dBm$, $V_{CTL}=2.8V$
0.70dB typ. @f=1.9GHz, $P_{IN}=25dBm$, $V_{CTL}=2.8V$
- High isolation 26.5dB typ. @f=0.9GHz, $P_{IN}=31dBm$, $V_{CTL}=2.8V$
20dB typ. @f=1.9GHz, $P_{IN}=25dBm$, $V_{CTL}=2.8V$
- Low control current 10uA typ. @f=0.9GHz, $P_{IN}=31dBm$, $V_{CTL}=2.8V$
- Ultra small & ultra thin package FLP10-C1 (Package size: 3.0x2.8x0.75mm)

■PIN CONFIGURATION

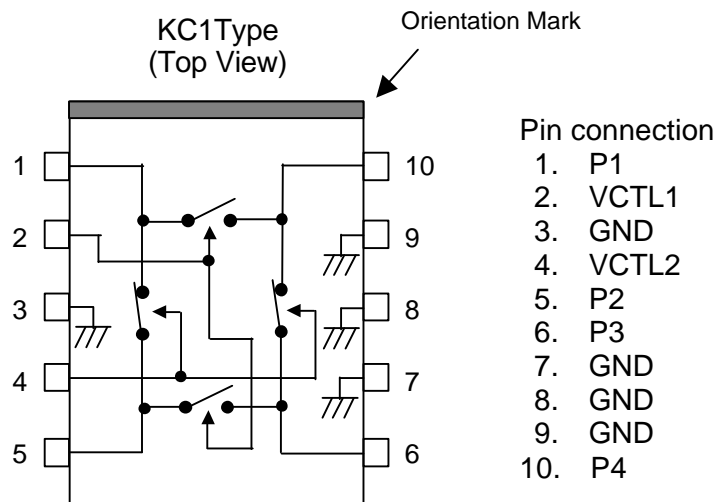

■TRUTH TABLE

ON Pass	VCTL1	VCTL2
P1-P2	L	H
P3-P4	L	H
P1-P4	H	L
P2-P3	H	L

NOTE: Please note that any information on this catalog is subject to change.

NJG1528KC1

■ABSOLUTE MAXIMUM RATINGS

($T_a=+25^{\circ}\text{C}$, $Z_s=Z_l=50\Omega$)

PARAMETER	SYMBOL	CONDITIONS	RATINGS	UNITS
RF Input Power	P_{IN}	$V_{CTL(L)}=0\text{V}$, $V_{CTL(H)}=3\text{V}$	37.5	dBm
Operating Voltage	V_{CTL}	$V_{CTL(H)}-V_{CTL(L)}$	12	V
Power Dissipation	P_D		550	mW
Operating Temp.	T_{opr}		-40~+85	$^{\circ}\text{C}$
Storage Tempe.	T_{stg}		-55~+125	$^{\circ}\text{C}$

■ELECTRICAL CHARACTERISTICS

(General conditions: $T_a=+25^{\circ}\text{C}$, $Z_s=Z_l=50\Omega$, $V_{CTL(L)}=0\text{V}$, $V_{CTL(H)}=2.8\text{V}$)

PARAMETER	SYMBOL	CONDITIONS	MIN	TYP	MAX	UNITS
Control Voltage (Low)	$V_{CTL(L)}$	$f=0.01\sim 2.5\text{GHz}$	-0.2	0	0.2	V
Control Voltage (High)	$V_{CTL(H)}$	$f=0.01\sim 2.5\text{GHz}$	2.5	2.8	6.5	V
Control Current	I_{CTL}	$f=0.9\text{GHz}$, $P_{IN}=31\text{dBm}$	-	10	20	μA
Insertion loss 1	LOSS1	$f=0.9\text{GHz}$, $P_{IN}=31\text{dBm}$	-	0.60	0.70	dB
Insertion loss 2	LOSS2	$f=1.9\text{GHz}$, $P_{IN}=25\text{dBm}$	-	0.70	0.85	dB
Isolation 1	ISL1	$f=0.9\text{GHz}$, $P_{IN}=31\text{dBm}$	24.5	26.5	-	dB
Isolation 2	ISL2	$f=0.9\text{GHz}$, $P_{IN}=31\text{dBm}$	22	24	-	dB
Isolation 3	ISL3	$f=1.9\text{GHz}$, $P_{IN}=25\text{dBm}$	18	20	-	dB
Isolation 4	ISL4	$f=1.9\text{GHz}$, $P_{IN}=25\text{dBm}$	17	18	-	dB
Pin at 0.2dB Compression point	$P_{-0.2\text{dB}}$	$f=1.9\text{GHz}$	34	36	-	dBm
2nd Harmonics 1	$2f_0(1)$	$f=0.9\text{GHz}$, $P_{IN}=25\text{dBm}$	-	-	-70	dBc
2nd Harmonics 2	$2f_0(2)$	$f=1.9\text{GHz}$, $P_{IN}=25\text{dBm}$	-	-	-65	dBc
3rd Harmonics 1	$3f_0(1)$	$f=0.9\text{GHz}$, $P_{IN}=25\text{dBm}$	-	-	-65	dBc
3rd Harmonics 2	$3f_0(2)$	$f=1.9\text{GHz}$, $P_{IN}=25\text{dBm}$	-	-	-65	dBc
Input 3rd order intercept Point 1	IIP3(1)	$f=900+901\text{MHz}$, $P_{in}=25\text{dBm}$ *1	-	60	-	dBm
Input 3rd order intercept Point 2	IIP3(2)	$f=1900+1901\text{MHz}$, $P_{in}=25\text{dBm}$ *1	-	60	-	dBm
VSWR	$VSWR_i$	on-state ports, $f=1.9\text{GHz}$	-	1.1	1.3	
Switching time	T_{SW}	$f=0.1\sim 2.5\text{GHz}$	-	100	-	ns

*1: The input IP3 is defined as following equation.

$$IIP3 = (3 \times P_{out} - IM3) / 2 + LOSS$$

■TERMINAL INFORMATION

No.	SYMBOL	EXPLANATION
1	P1	RF port. This port is connected with P2 port by controlling 2pin- $V_{CTL(H)}$ (+2.5~+6.5V) and 4pin- $V_{CTL(L)}$ (-0.2~+0.2V). This port is connected with P4 port by controlling 2pin- $V_{CTL(L)}$ (-0.2~+0.2V) and 4pin- $V_{CTL(H)}$ (+2.5~+6.5V). A DC cut capacitor 56pF is required at this terminal to block DC voltage of inner circuit.
2	VCTL1	Control port1. Please connect bypass capacitor (10pF) between this terminal and GND close to this IC.
3	GND	Ground terminal. Please connect this terminal with ground plane as close as possible for excellent RF performance.
4	VCTL2	Control port2. Please connect bypass capacitor (10pF) between this terminal and GND close to this IC.
5	P2	RF port. This port is connected with P1 port by controlling 2pin- $V_{CTL(L)}$ (-0.2~+0.2V) and 4pin- $V_{CTL(H)}$ (+2.5~+6.5V). This port is connected with P3 port by controlling 2pin- $V_{CTL(H)}$ (+2.5~+6.5V) and 4pin- $V_{CTL(L)}$ (-0.2~+0.2V). A DC cut capacitor 56pF is required at this terminal to block DC voltage of inner circuit.
6	P3	RF port. This port is connected with P2 port by controlling 2pin- $V_{CTL(H)}$ (+2.5~+6.5V) and 4pin- $V_{CTL(L)}$ (-0.2~+0.2V). This port is connected with P4 port by controlling 2pin- $V_{CTL(L)}$ (-0.2~+0.2V) and 4pin- $V_{CTL(H)}$ (+2.5~+6.5V). A DC cut capacitor 56pF is required at this terminal to block DC voltage of inner circuit.
7	GND	Ground terminal. Please connect this terminal with ground plane as close as possible for excellent RF performance.
8	GND	Ground terminal. Please connect this terminal with ground plane as close as possible for excellent RF performance.
9	GND	Ground terminal. Please connect this terminal with ground plane as close as possible for excellent RF performance.
10	P4	RF port. This port is connected with P1 port by controlling 2pin- $V_{CTL(H)}$ (+2.5~+6.5V) and 4pin- $V_{CTL(L)}$ (-0.2~+0.2V). This port is connected with P3 port by controlling 2pin- $V_{CTL(L)}$ (-0.2~+0.2V) and 4pin- $V_{CTL(H)}$ (+2.5~+6.5V). A DC cut capacitor 56pF is required at this terminal to block DC voltage of inner circuit.

NJG1528KC1

■ ELECTRICAL CHARACTERISTICS

(with application circuit, losses of PCB, connector and DC blocking capacitor are excluded)

P1-P2 Insertion Loss vs.Frequency
(VCTL1=0V, VCTL2=2.8V, Pin=-10dBm)

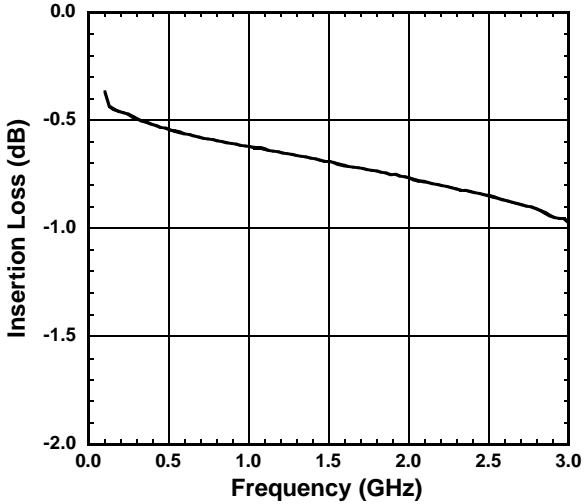

P3-P4 Insertion Loss vs.Frequency
(VCTL1=0V, VCTL2=2.8V, Pin=-10dBm)

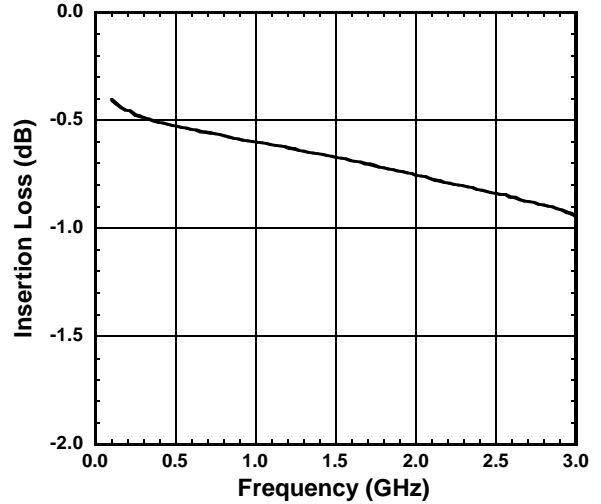

P1-P2 Isolation vs.Frequency
(VCTL1=2.8V, VCTL2=0V, Pin=-10dBm)

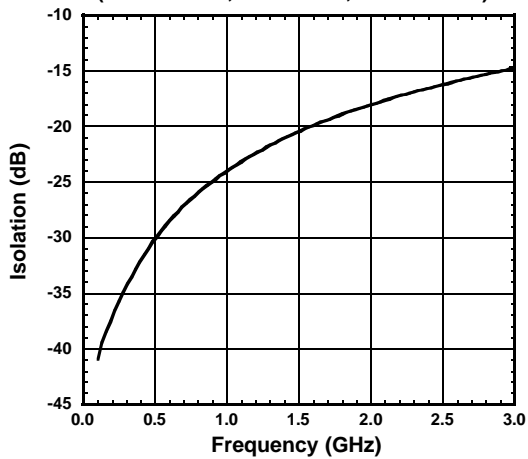

P1-P4 Isolation vs.Frequency
(VCTL1=0V, VCTL2=2.8V, Pin=-10dBm)

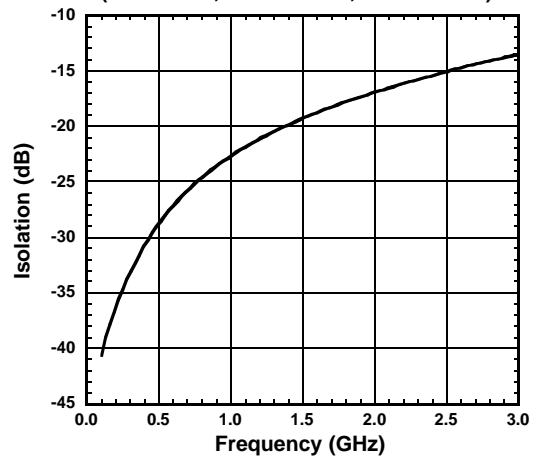

P1-P3 Isolation vs.Frequency
(VCTL1=0V, VCTL2=2.8V, Pin=-10dBm)

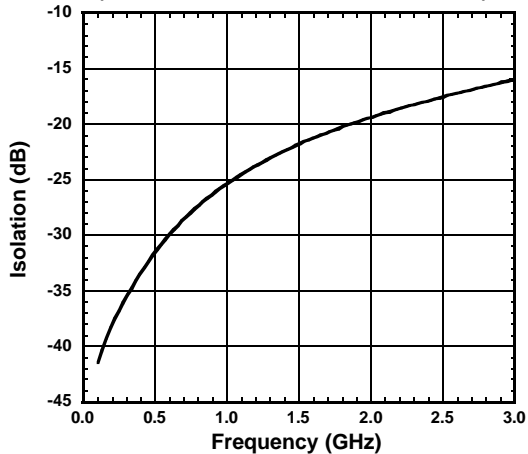

P1-P2(on) VSWR vs. Frequency

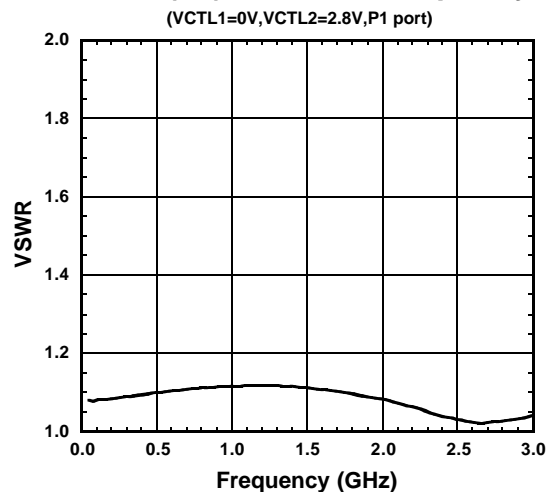

■ ELECTRICAL CHARACTERISTICS

(with application circuit, losses of PCB, connector and DC blocking capacitor are excluded)

Output Power, Control Current vs. Input Power
(P1-P2 ON, f=900MHz)

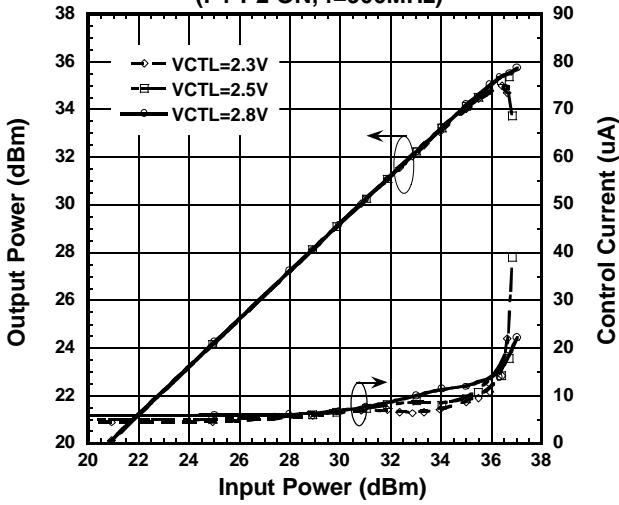

Output Power, Control Current vs. Input Power
(P1-P2 ON, f=900MHz)

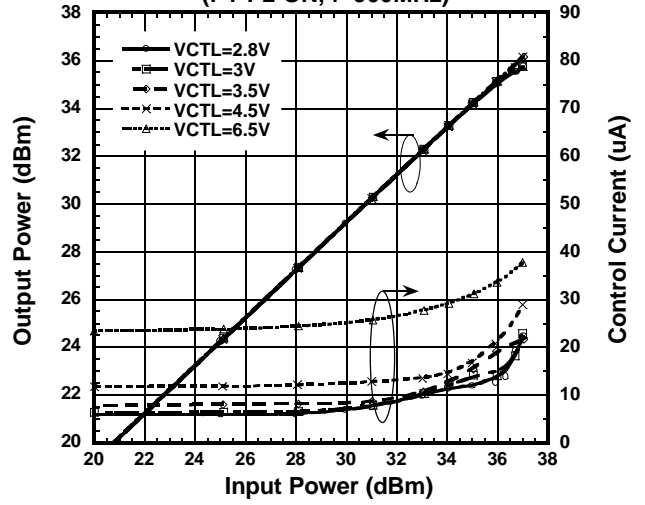

Output Power, Control Current vs. Input Power
(P1-P2 ON, f=1.9GHz)

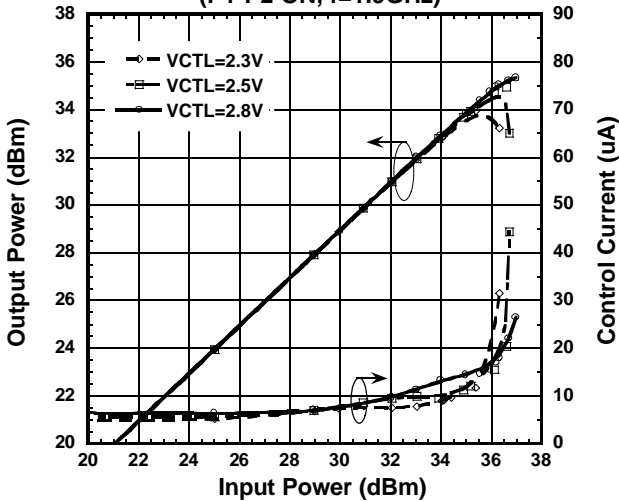

Output Power, Control Current vs. Input Power
(P1-P2 ON, f=1.9GHz)

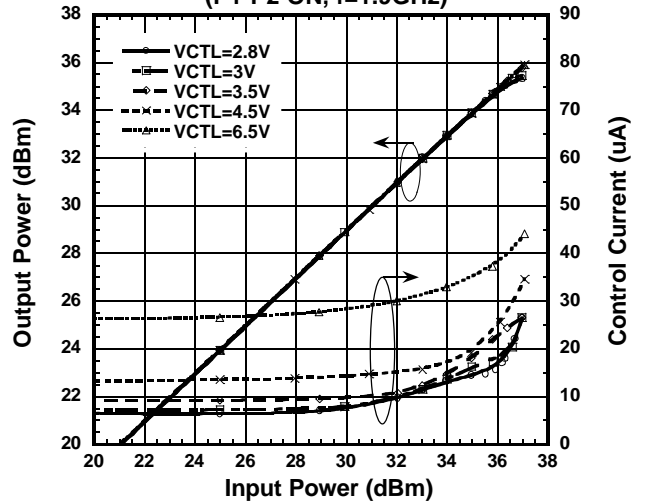

Insertion Loss vs. Input Power
(P1-P2 ON, f=900MHz)

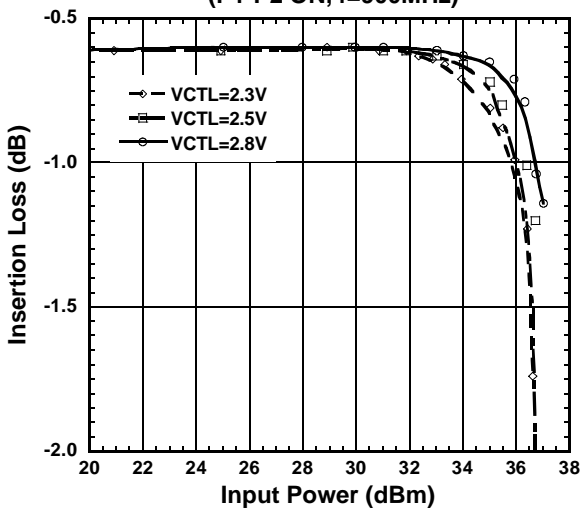

Insertion Loss vs. Input Power
(P1-P2 ON, f=900MHz)

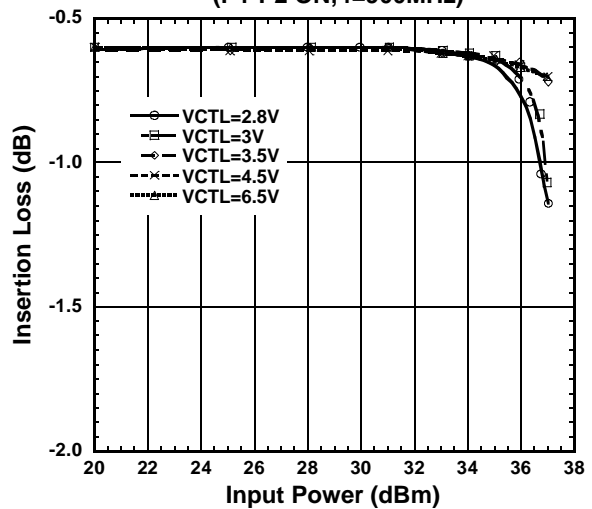

NJG1528KC1

ELECTRICAL CHARACTERISTICS

(with application circuit, losses of PCB, connector and DC blocking capacitor are excluded)

Insertion Loss vs. Input Power
(P1-P2 ON, f=1.9GHz)

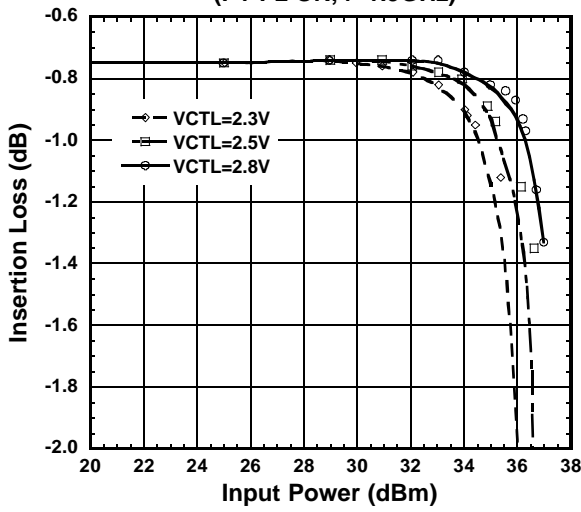

Insertion Loss vs. Input Power
(P1-P2 ON, f=1.9GHz)

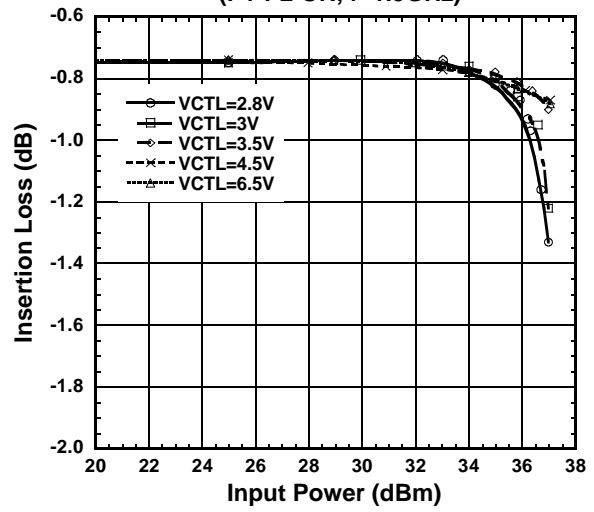

Isolation vs. Input Power
(P1-P2, f=900MHz)

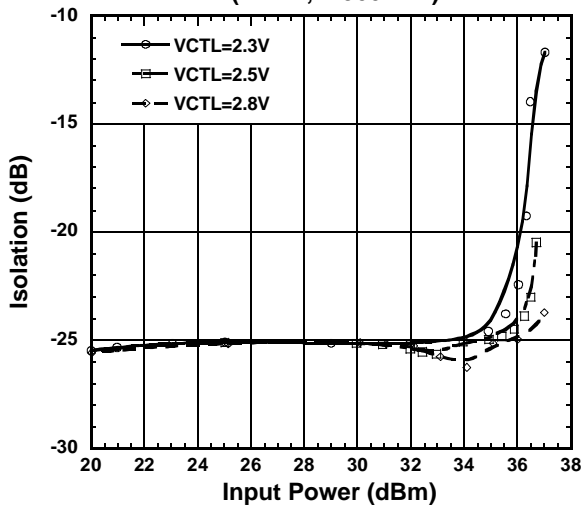

Isolation vs. Input Power
(P1-P2, f=900MHz)

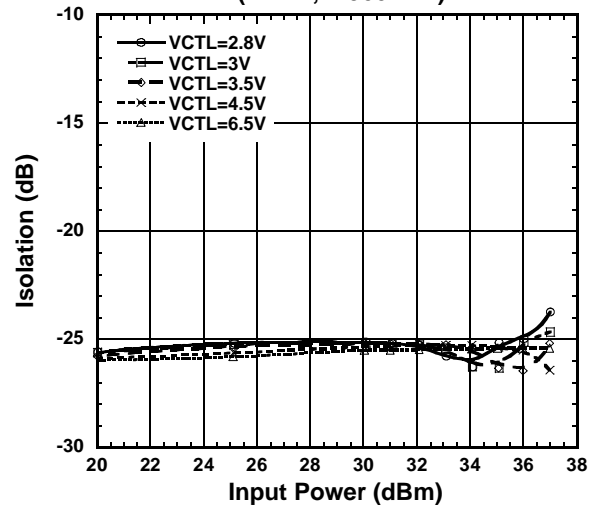

Isolation vs. Input Power
(P1-P2, f=1.9GHz)

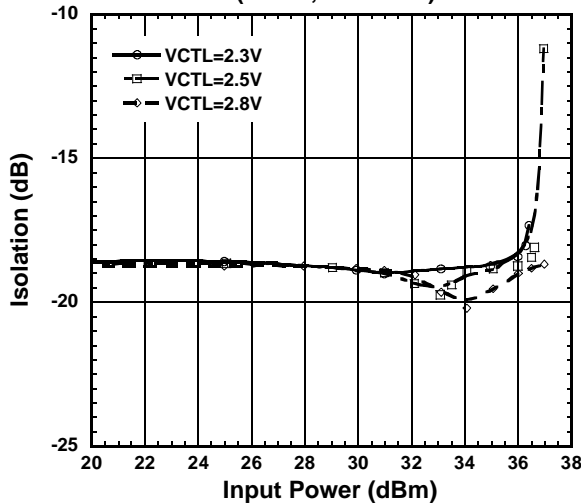

Isolation vs. Input Power
(P1-P2, f=1.9GHz)

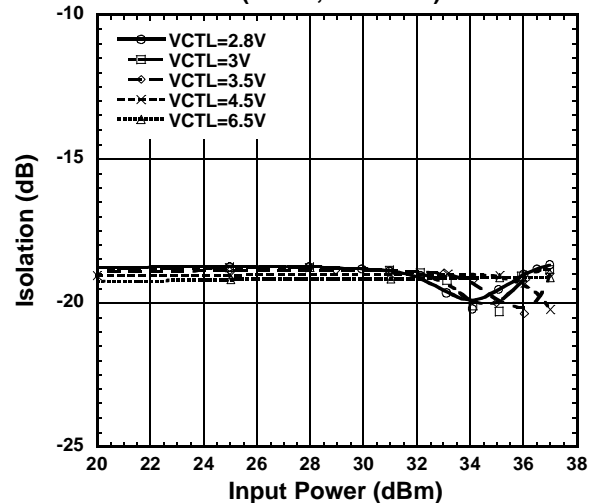

■ ELECTRICAL CHARACTERISTICS (with application circuit)

IM3 vs. Input Power
(P1-P2 ON, $f=1.9+1.901\text{GHz}$)

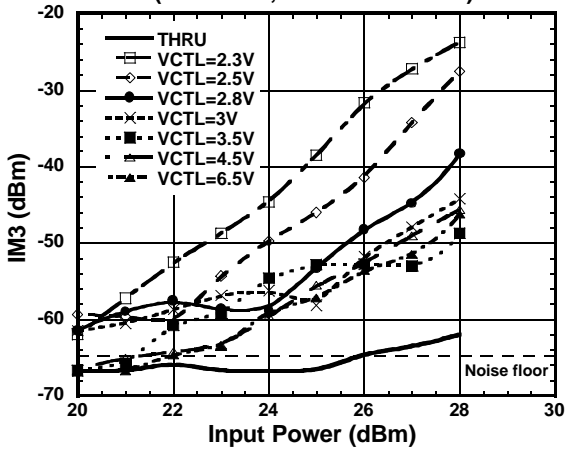

IM3 vs. Input Power
(P1-P2 ON, $f=900+901\text{MHz}$)

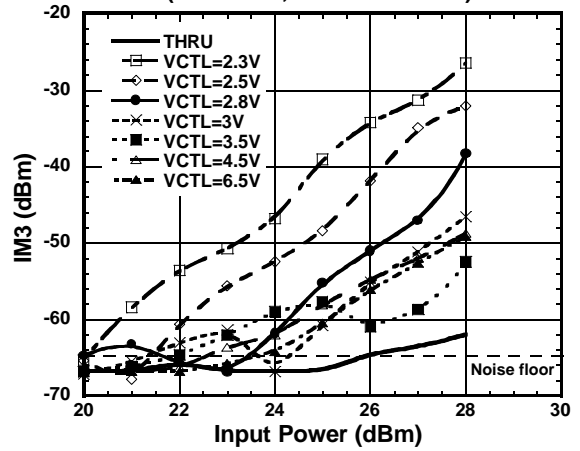

Output Power, IM3 vs. Input Power
(P1-P2 ON, $f=900+901\text{MHz}$)

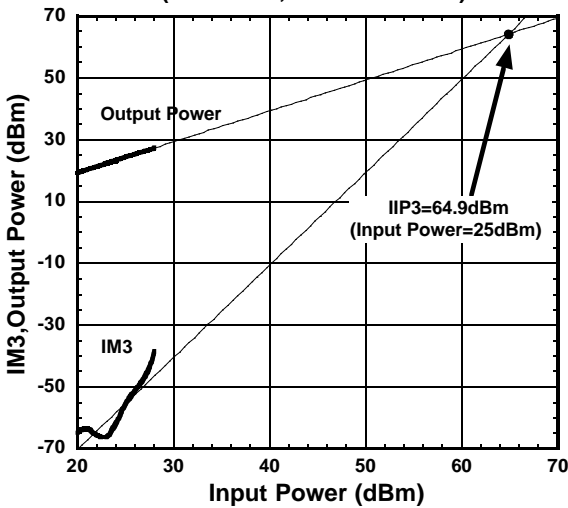

Output Power, IM3 vs. Input Power
(P1-P2 ON, $f=1.9+1.901\text{GHz}$)

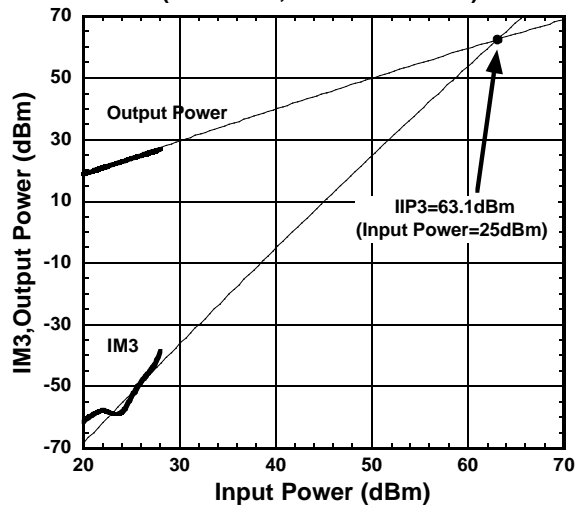

IIP3 vs. Input Power
(P1-P2 ON, $f=900+901\text{MHz}$)

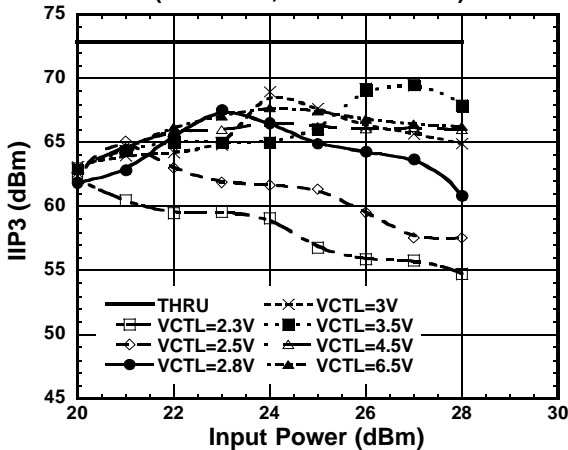

IIP3 vs. Input Power
(P1-P2 ON, $f=1.9+1.901\text{GHz}$)

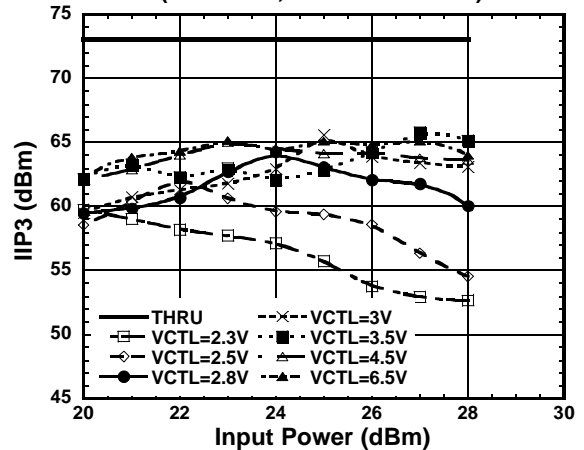

NJG1528KC1

ELECTRICAL CHARACTERISTICS (with application circuit)

2nd Harmonics vs. Input Power
(P1-P2 ON, f=900MHz)

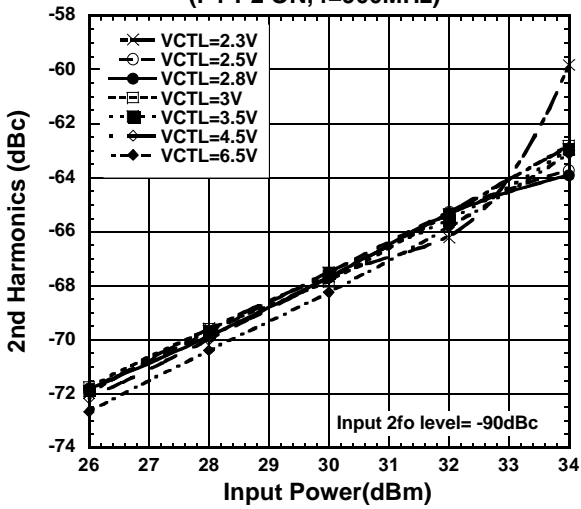

2nd Harmonics vs. Input Power
(P1-P2 ON, f=1.9GHz)

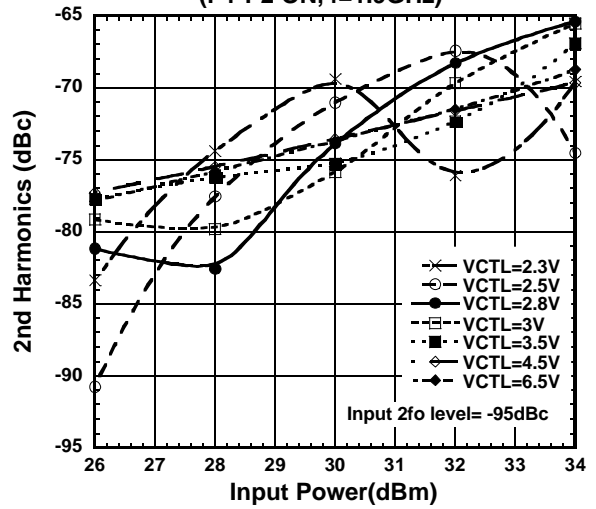

3rd Harmonics vs. Input Power
(P1-P2 ON, f=900MHz)

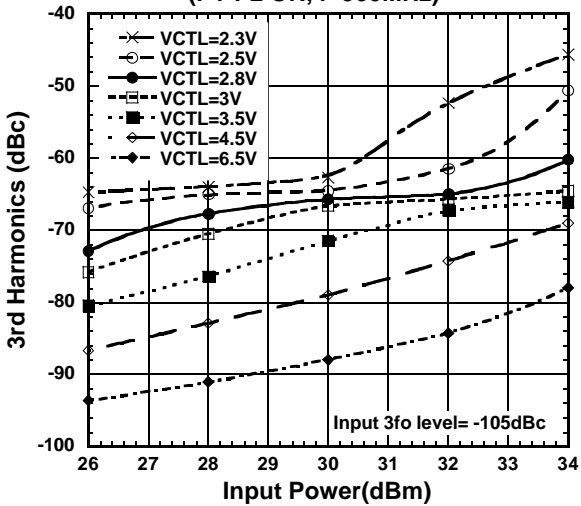

3rd Harmonics vs. Input Power
(P1-P2 ON, f=1.9GHz)

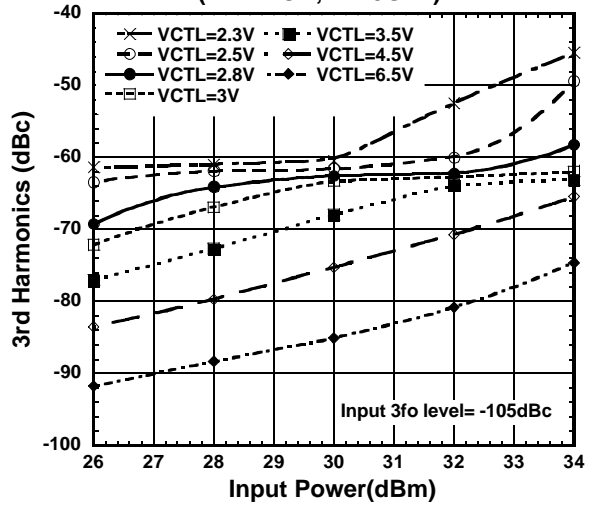

APPLICATION CIRCUIT

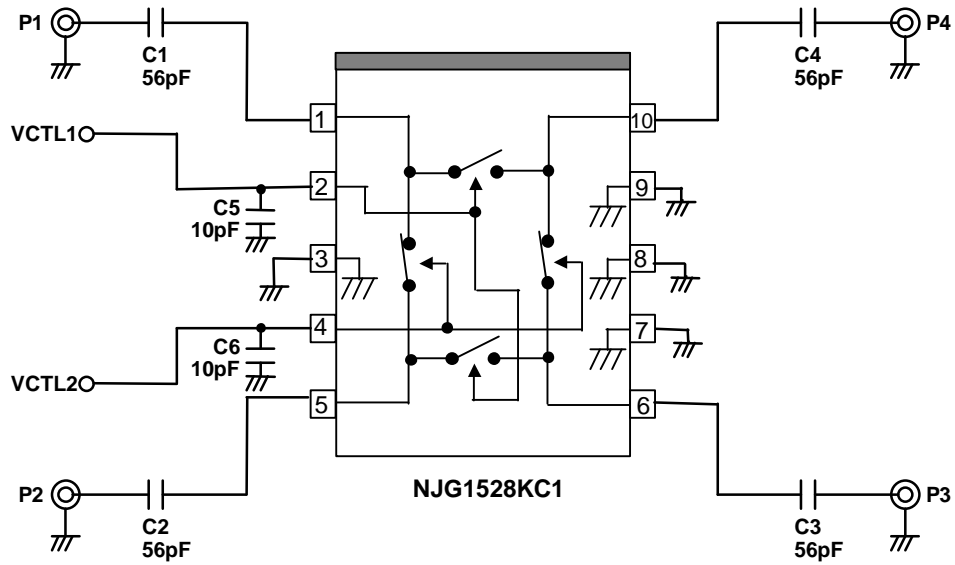

PARTS LIST

Parts No.	f=0.05-0.1GHz	f=0.1-0.5GHz	f=0.5-2.5GHz	Comment
C1 ~ C4	0.01uF	1000pF	56pF	MURATA (GRM36)
C5 ,C6	10pF	10pF	10pF	MURATA (GRM36)

RECOMMENDED PCB DESIGN

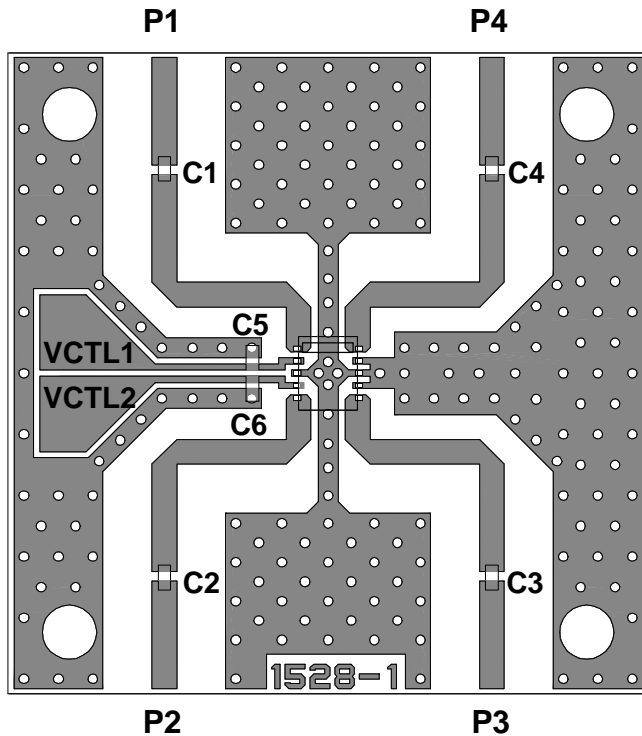

PCB SIZE=26x26 mm
 PCB: FR-4 t=0.5mm
 CAPACITOR: size 1005
 STRIP LINE WIDTH=1.0mm

NJG1528KC1

PACKAGE OUTLINE (FLP10-C1)

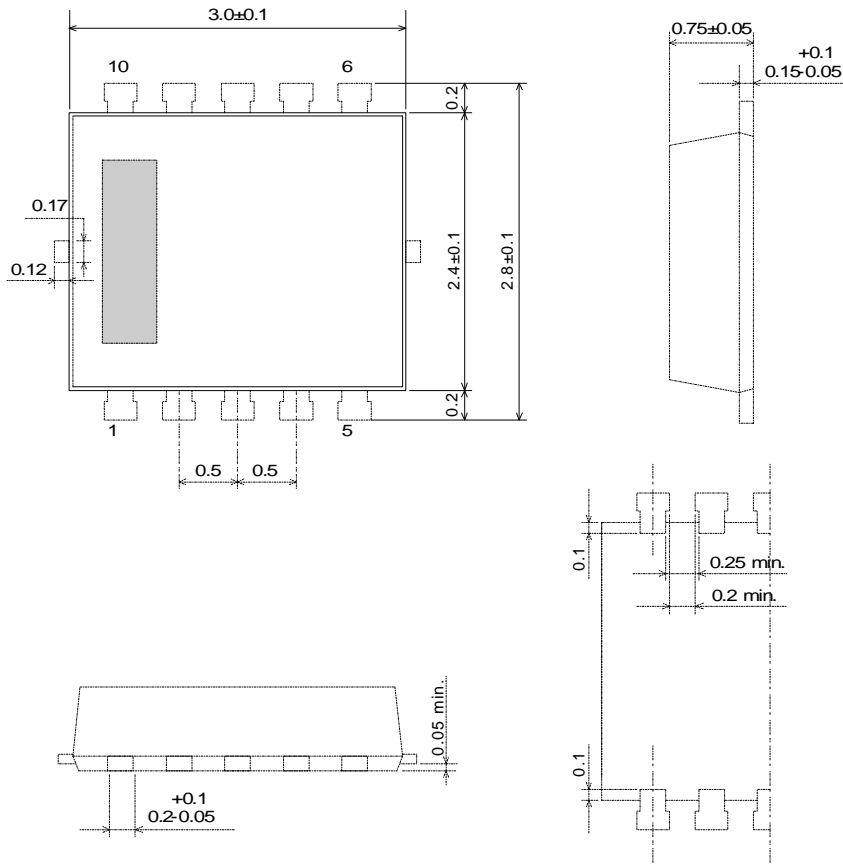

Lead material	: Copper
Lead surface finish	: Solder plating
Molding material	: Epoxy resin
UNIT	: mm
Weight	: 15mg

Cautions on using this product

This product contains Gallium-Arsenide (GaAs) which is a harmful material.

- Do NOT eat or put into mouth.
- Do NOT dispose in fire or break up this product.
- Do NOT chemically make gas or powder with this product.
- To waste this product, please obey the relating law of your country.

[CAUTION]

The specifications on this databook are only given for information, without any guarantee as regards either mistakes or omissions. The application circuits in this databook are described only to show representative usages of the product and not intended for the guarantee or permission of any right including the industrial rights.

This product may be damaged with electric static discharge (ESD) or spike voltage. Please handle with care to avoid these damages.